

LONCIN 隆鑫

General power products

Gasoline Generator

LC1200

Owner's Manual



CONTENTS

- 1. SAFETY 1
- 2. COMPONENT IDENTIFICATION 3
- 3. PREOPERATION CHECK 4
- 4. CONTROLS 8
- 5. GENERATOR USE 9
- 6. STOPPING THE ENGINE 14
- 7. MAINTENANCE 15
- 8. STORAGE 19
- 9. TROUBLE SHOOTING 21
- 10. SPECIFICATIONS 24
- 11. CIRCUIT DIAGRAM 25

1. SAFETY

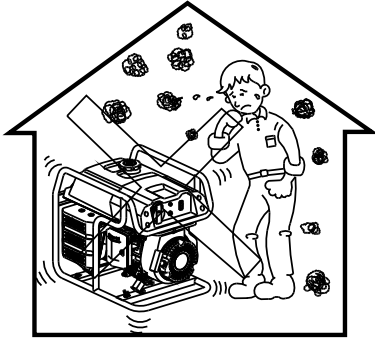

Never use it indoors

Never use it in a wet condition

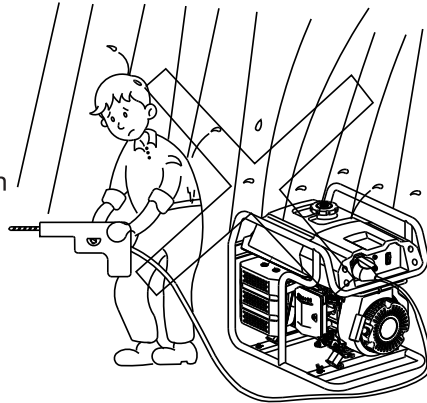

Never directly connect it to a home power system

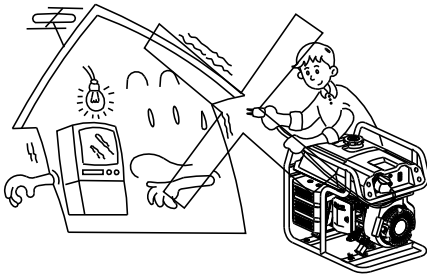

Keep it at least 1m away from inflammables

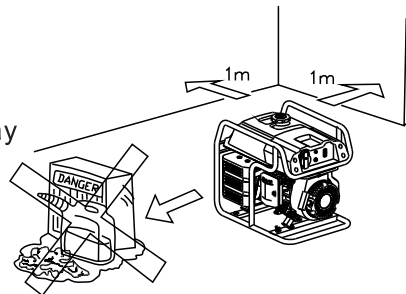

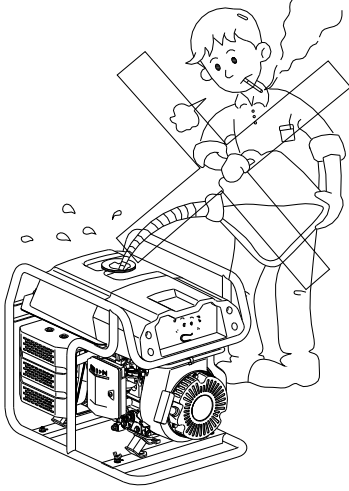

Never smoke when fueling

Don't spill when fueling

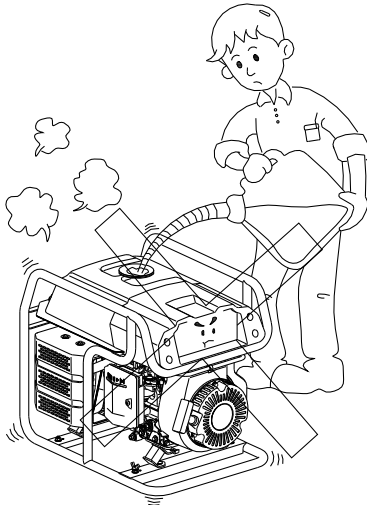
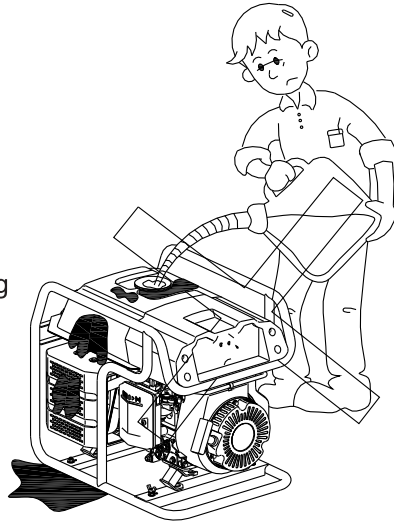

Stop the engine before fueling

2. COMPONENT IDENTIFICATION

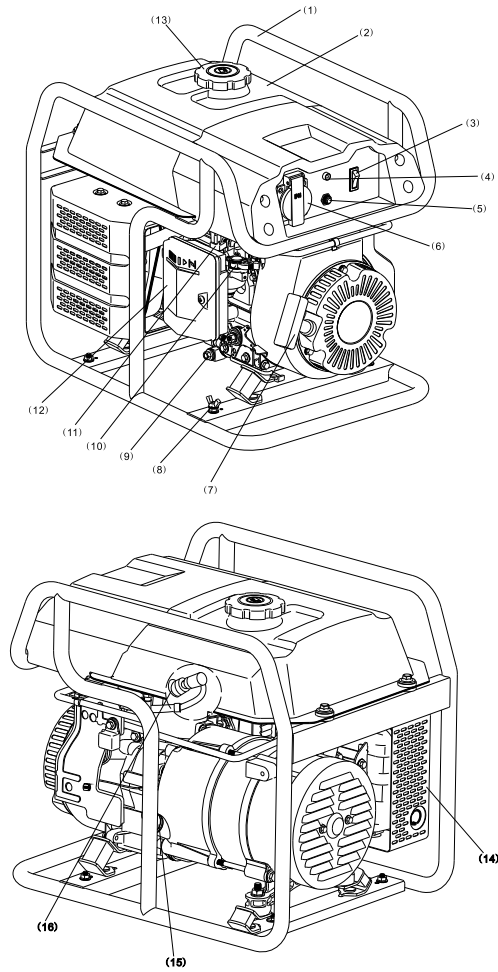

- | | |
|--------------------------|---------------------|
| (1) FRAME | (9) OIL DRAIN PLUG |
| (2) FUEL TANK | (10) FUEL SWITCH |
| (3) ENGINE SWITCH | (11) CHOKE LEVER |
| (4) INDICATOR | (12) AIR CLEANER |
| (5) AC CIRCUIT PROTECTOR | (13) FUEL TANK CAP |
| (6) AC SOCKET | (14) MUFFLER |
| (7) RECOIL STARTER GRIP | (15) OIL FILLER CAP |
| (8) GROUND TERMINAL | (16) SPARK PLUG |

3. PREOPERATION CHECK

- Suitable temperature range for generator unit: -15°C - 48°C .
- Suitable humidity range for generator unit: Lower than 95%.
- When applied at places with an altitude lower than 100m, rated power is available, and when higher than 1000m, power will be lower.

1) Engine oil

Note: Engine oil is a major factor affecting engine performance and service life. Non-detergent and 2-stroke engine oils will damage the engine and are not recommended.

Check the oil level BEFORE EACH USE with the generator on a level surface with the engine stopped.

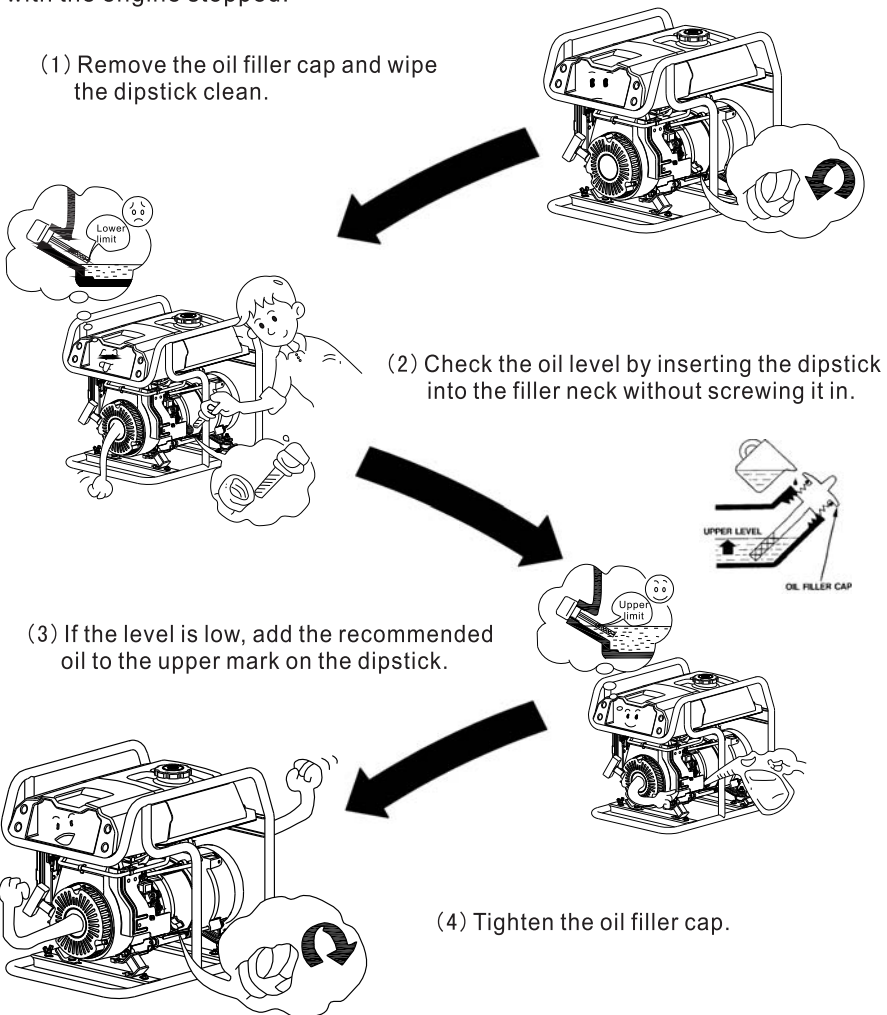

Engine oil filling amount: 300ml.

Oil recommended: 4-stroke gasoline engine oil

API SE and SF or oil equivalent to SG grade (SAE10W-30).

When under low temperature (below 10°C), as a recommendation, SAE10W-30 shall be applied.

When it is extremely chilly, (below -15°C), API SE and SF or oil equivalent to SG grade (SAE5W-30).

Note: when the generator unit is operating, if large amount of engine oil flows down from the air filter, please shut down the engine (the same as shown in Page 16). Then discharge the excessive engine oil and maintain the engine oil amount at 300ml in the crankcase and the air filter cartridge shall be cleaned (the same as shown in Page 7).

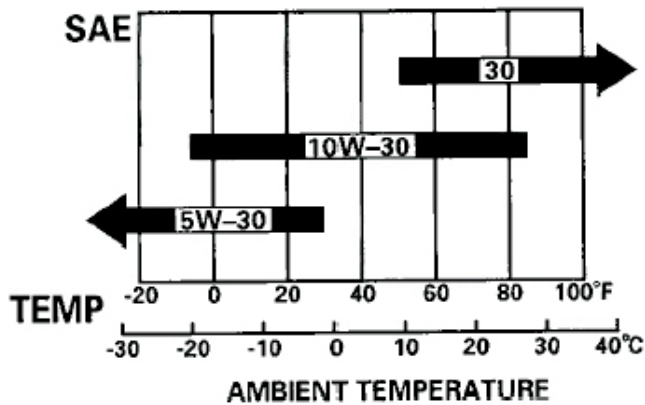

2) Fuel Oil Level

(1). Open the fuel tank cap.

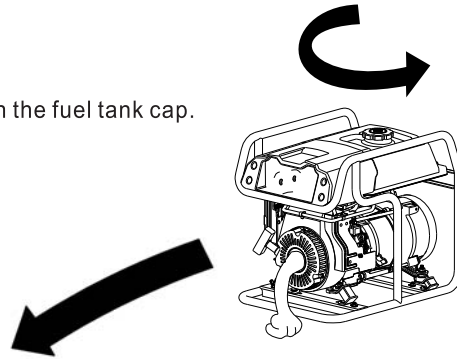

(2). Check fuel oil level, refill the tank if the fuel level is low. Do not fill above the shoulder of the fuel strainer.

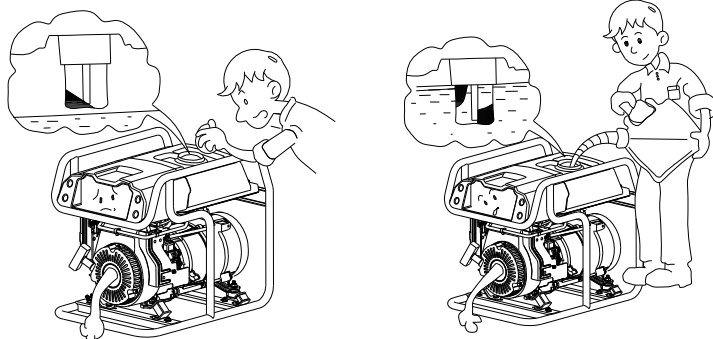

(3). Fix the oil tank cap.

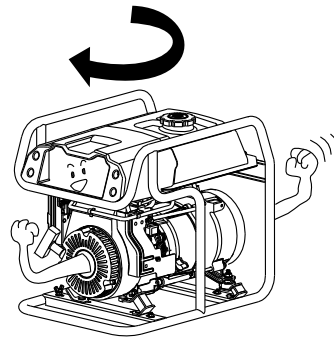

3) Air cleaner

- (1). Take down the screw by a driver, remove the air cleaner cover and remove the element.

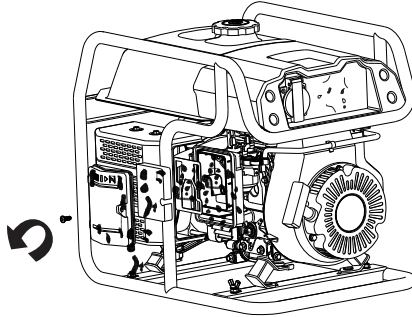

- (2). Check the air cleaner element, if the element has got dirty, wash the element in a solution of household detergent and warm water, then rinse thoroughly; or wash in nonflammable or high flash point solvent. Allow the element to dry thoroughly. Soak the element in clean engine oil and squeeze out the excess oil. The engine will smoke during initial-up if too much oil is left in the element.

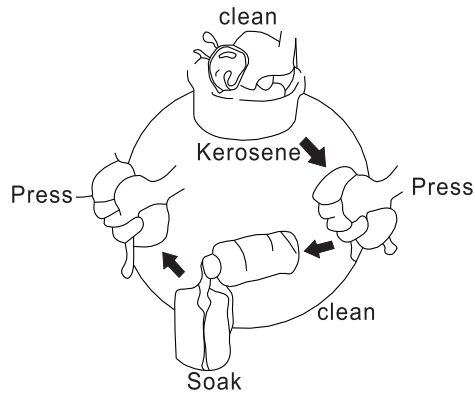

- (3). Reinstall the air cleaner element and the cover.

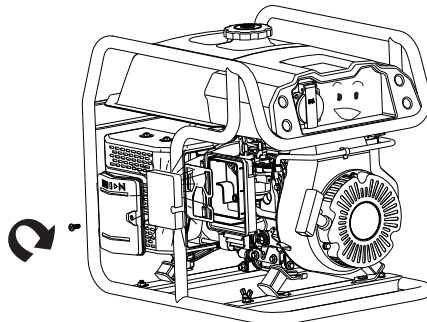

4. CONTROLS

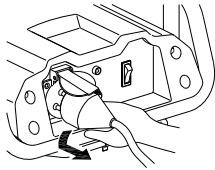

figure 4-1

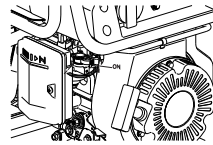

figure 4-2

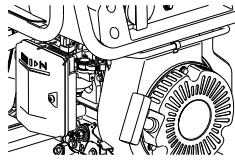

figure 4-3

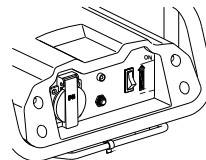

figure 4-4

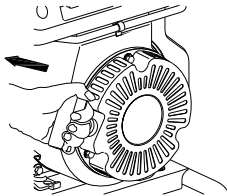

figure 4-5

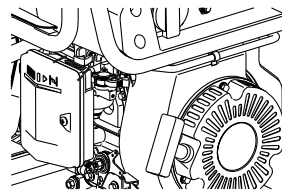

figure 4-6

- (1). Disconnect all load from the AC socket(See figure 4-1).
- (2). Turn the fuel valve to "ON" (See figure 4-2).
- (3). Pull the choke lever to "Close" (See figure 4-3).
- (4). Turn the engine switch to "ON" (See figure 4-4).
- (5). Pull the start handle until resistance is felt, and then yank it(See figure 4-5).
- (6). When the engine starts up, operate the choke valve as per that is shown by the arrow (See figure 4-6).





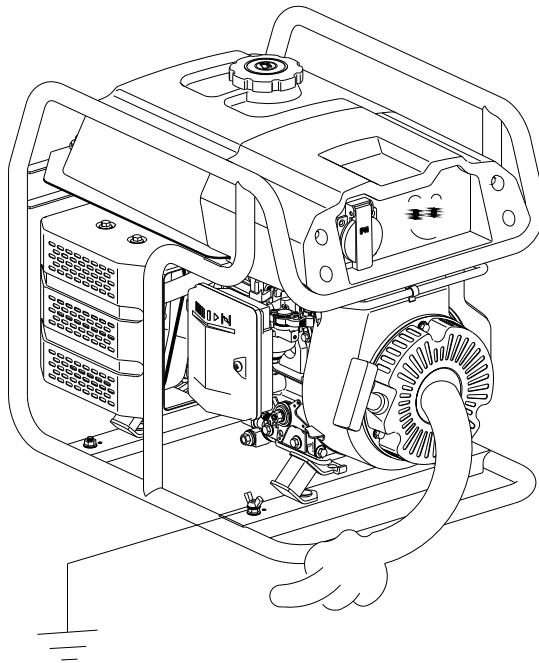

5. GENERATOR USE

The follow specification shall be complied with, so as to maintain the best mechanical and electrical status.

- 1). The generator unit **MUST** be grounded, in order to prevent misuse of electricity.

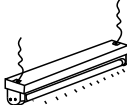
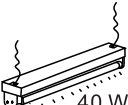

2).Electrical appliance, especially motor driving units will cause extremely large current during startup; when these facilities are to be connected to the generator, the following table shall be taken as reference.
The sum of load power shall be no more than the rated power of the generator.

| Model | Watts | | Typical facilities | Example | | |
|---|-------|-------|--|--|---------------|-----------|
| | Start | Rated | | Facilities | Start | Rated |
| <ul style="list-style-type: none"> ●Incandescent ●Heating | x1 | x1 | Incandescent  TV  | Incandescent  100W | 100VA (W) | 100VA (W) |
| <ul style="list-style-type: none"> ●Fluorescent | x2 | x1.5 |  Fluorescent |  40 W Fluorescent | 80VA (W) | 60VA (W) |
| <ul style="list-style-type: none"> ●Motor driving | x3-5 | x2 |  Refrigerator  Fan | Refrigerator  150 W | 450~750VA (W) | 300VA (W) |

3).When more than two loads are connected to the generator, please connect in series the load with higher startup current.

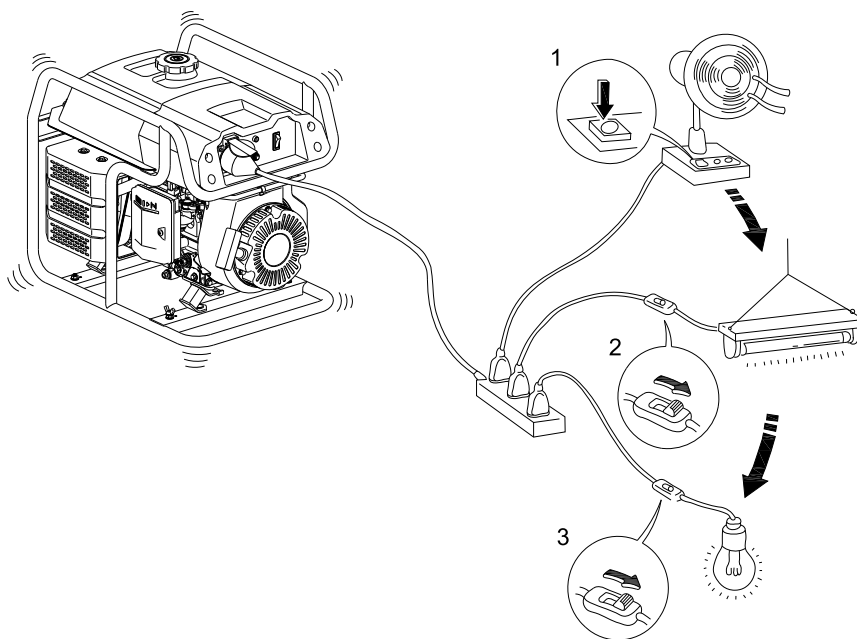

Note:

- When the generator is connected to family power supply, an experienced technician shall be required for connection.
- After the loads are connected to the generator, check whether the connection is right. If the circuit is not correctly connected, the generator unit will be damaged; or, possibly, fire will be rendered

○ Good

✗ Forbidden

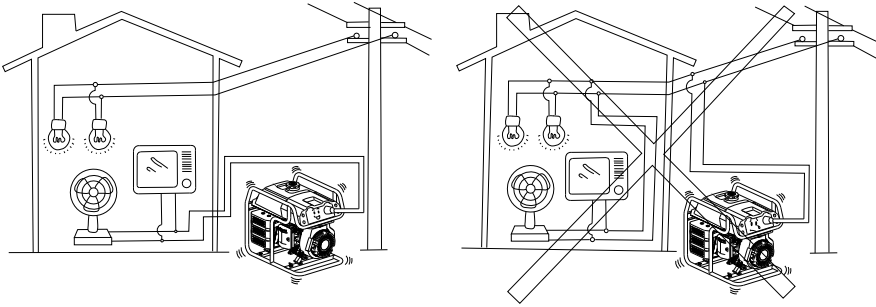

○ Good

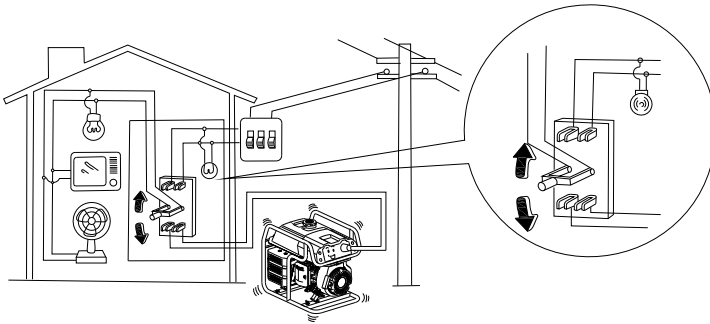

4).AC operation

(1). Start up the engine.

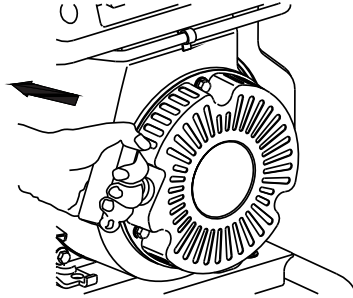

(2). Plug in the appliance.

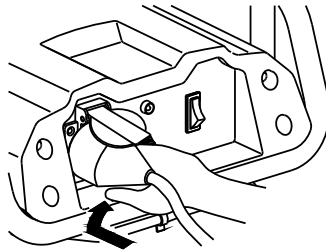

(3). Plug in the appliance.

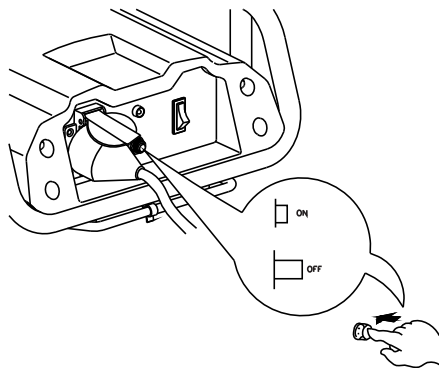

6. STOPPING THE ENGINE

(1). Disconnect the load.

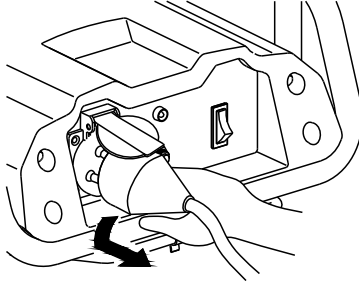

(2). Turn the engine switch to OFF position.

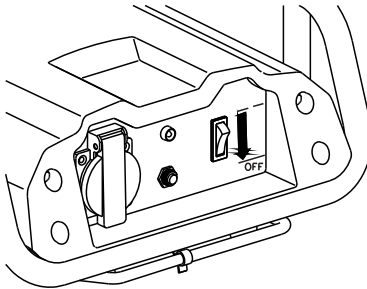

(3). Turn the fuel valve to the OFF position.

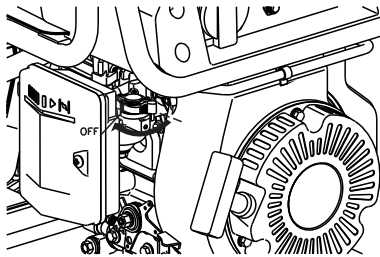



























Note:

To stop the engine in an emergency, move the engine switch to OFF position.

7. MAINTENANCE

 Check
  Change
  Clean
  Check and regulation

| Regular maintenance timetable |  |  |  |  |  | Ref. page |
|--|---|---|---|---|--|-----------|
| Engine oil  |  | | | | | 4 |
| Engine oil  | |  |  | | | 16 |
| Air cleaner  |  | |  | | | 7 |
| Spark plug  | | | |  |  | 18 |
| Valve clearance  | | | | |  | - |
| Cylinder head cap cleaning  | Every 300 hours  * ※ | | | | | - |
| Fuel tank cleaning  | Every two years  * | | | | | - |
| Filter fuel nozzle  | | | |  | | 19 |
| fuel line  | Every two years  * ※ | | | | | - |

Note:

* : This item maintenance shall be assisted by the dealer.

※: Must be changed.

When applied in places where there is too much dust, the components shall be more frequently changed.

When frequently used, maintenance interval shall comply with the time

specified in the table above so as to ensure long term application.

1) Engine oil change

(1). Remove the drain plug and sealing washer, oil filler cap, and drain the the oil.

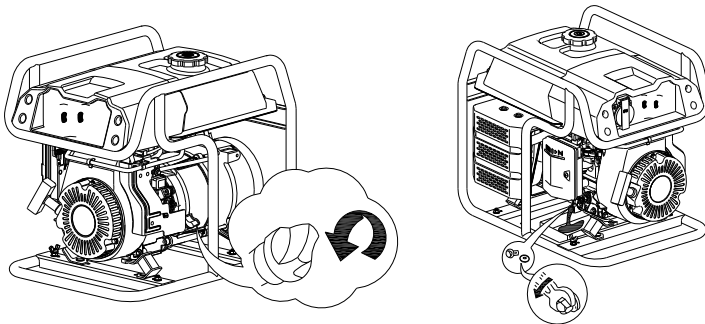

(2). Reinstall the drain plug and sealing washer. Tighten the plug securely.

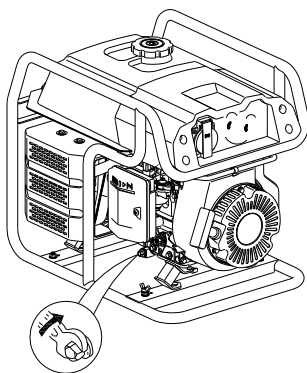

(3). Refill with the recommended oil and check the oil level.

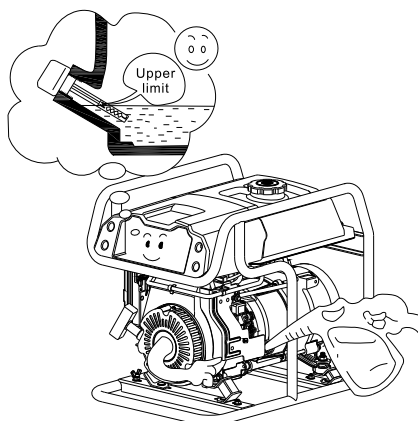

(4). Reinstall the filler cap.

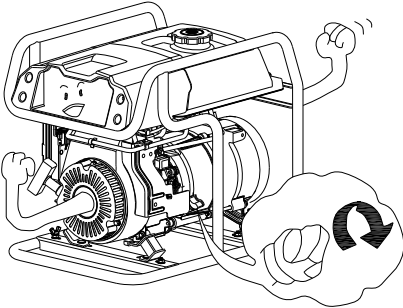

2). Air cleaner (the same as shown in Page 7)

3). Spark plug

(1). Remove the panel front casing and fuel tank; Then remove the spark plug cap.

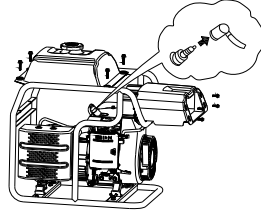

(2). Remove the spark plug.



(3). Clean any dirt from around the spark plug base.



(4). Measure the plug gap with a feeler gauge.

Correct as necessary by carefully bending the side electrode.

The gap should be: 0.70-0.80mm (0.028-0.031in).

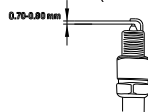

(5). Refit the spark plug and spark plug cap and then install properly the fuel tank and panel front casing.



4). Filter oil nozzle

Check whether the filter oil nozzle is dirty or blocked. If it cannot be cleaned, change a filter oil nozzle at a dealer shop

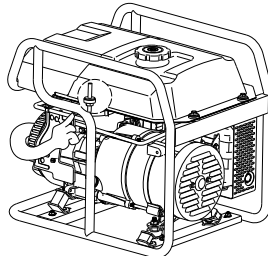

8.STORAGE

- (1). Turn off the fuel switch.

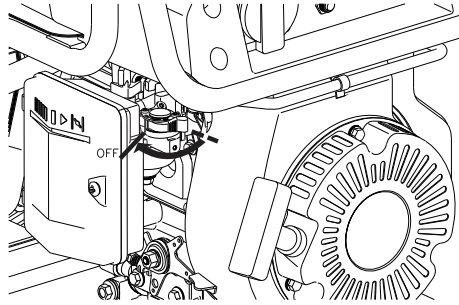

- (2). Drain the carburetor by loosening the drain screw. Drain the gasoline into a suitable container.

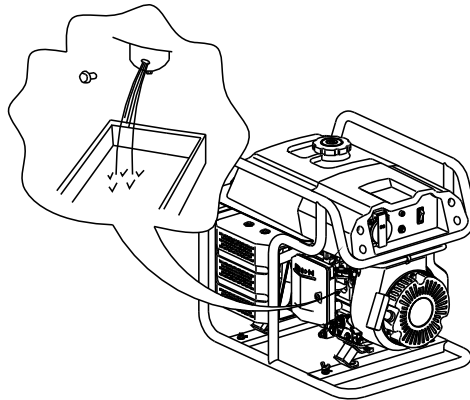

- (3). Change the engine oil.

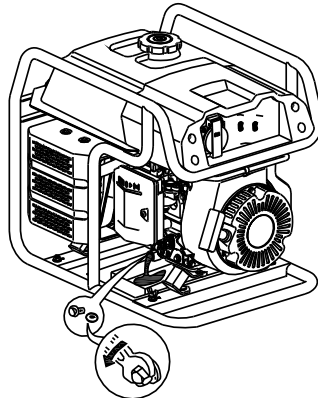

(4). Pull the recoil starter grip until resistance is felt.

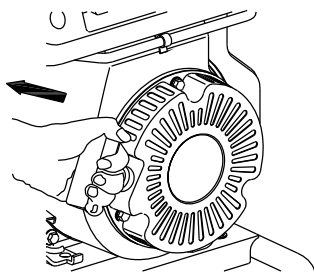

9.TROUBLESHOOTING

1) When the engine will not start:

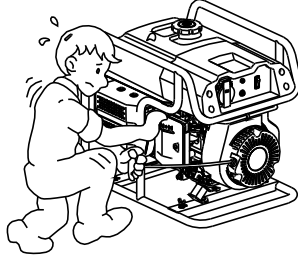

(1). Whether the engine switch is at "ON"?

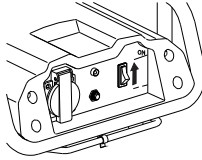

(2).Check the engine oil.

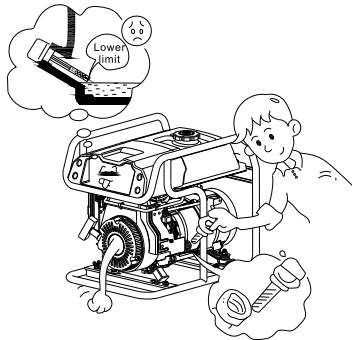

(3).Check the fuel oil.

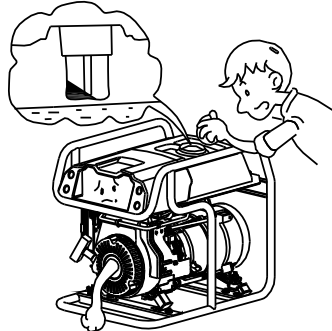

(4). Remove the spark plug; Check spark plug carbon deposition and clearance

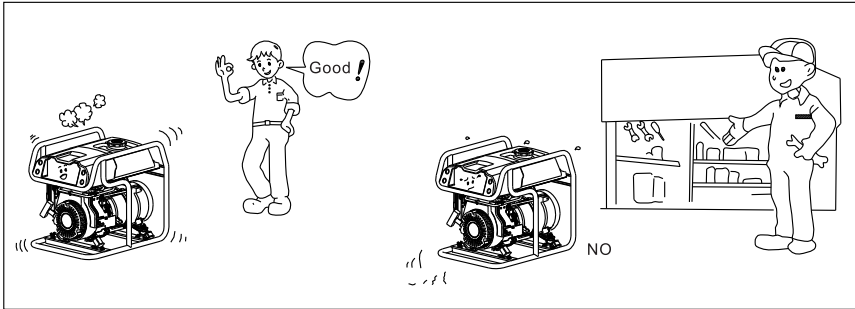
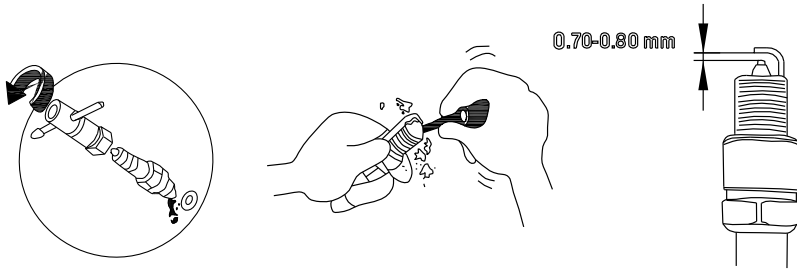

2) No electricity at the AC receptacles :

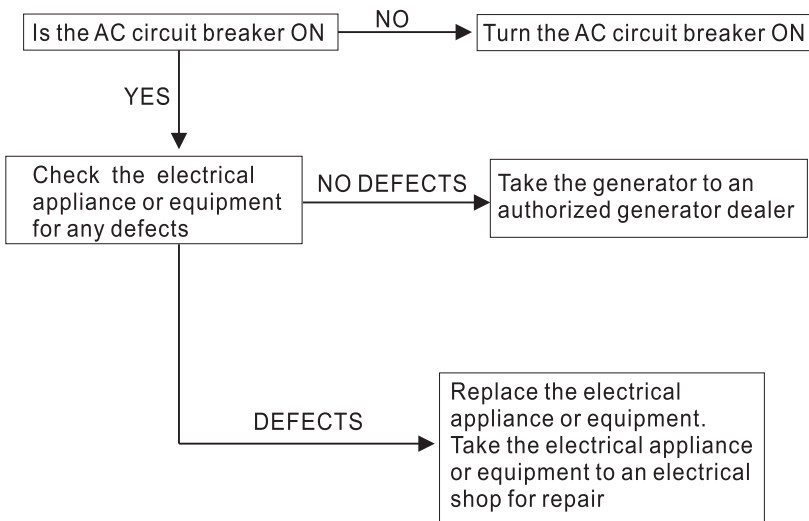
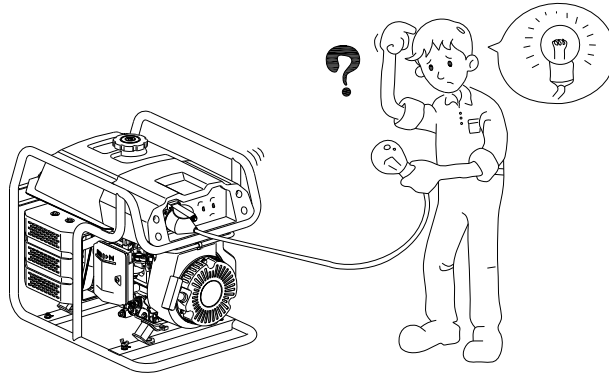

10. SPECIFICATIONS

| | | |
|---------------------------------|------------------------------|--|
| | Model | LC1200 |
| Engine | Engine model | LC152F |
| | Engine type | Single cylinder, 4-stroke, side air valve and forced air cooling |
| | Cylinder radius× stroke (mm) | 52×46 |
| | Compression ratio | 5. 6 : 1 |
| | Starting system | Manual recoil starter |
| | Ignition system | Transistor contactless ignition |
| | Displacement (ml) | 97 |
| | Engine oil capacity (L) | 0. 3 |
| Generator | Rated frequency (Hz) | 50 |
| | Rated voltage (V) | 220 |
| | Voltage regulation system | Automatic voltage regulation |
| | Rated power (W) | 800 |
| | Power coefficient | 1. 0 |
| | Oil tank capacity(L) | 4. 5 |
| Package size /L(mm)×W(mm)×H(mm) | | 480×355×435 |
| Net weight (Kg) | | 28 |

11. CIRCUIT DIAGRAM

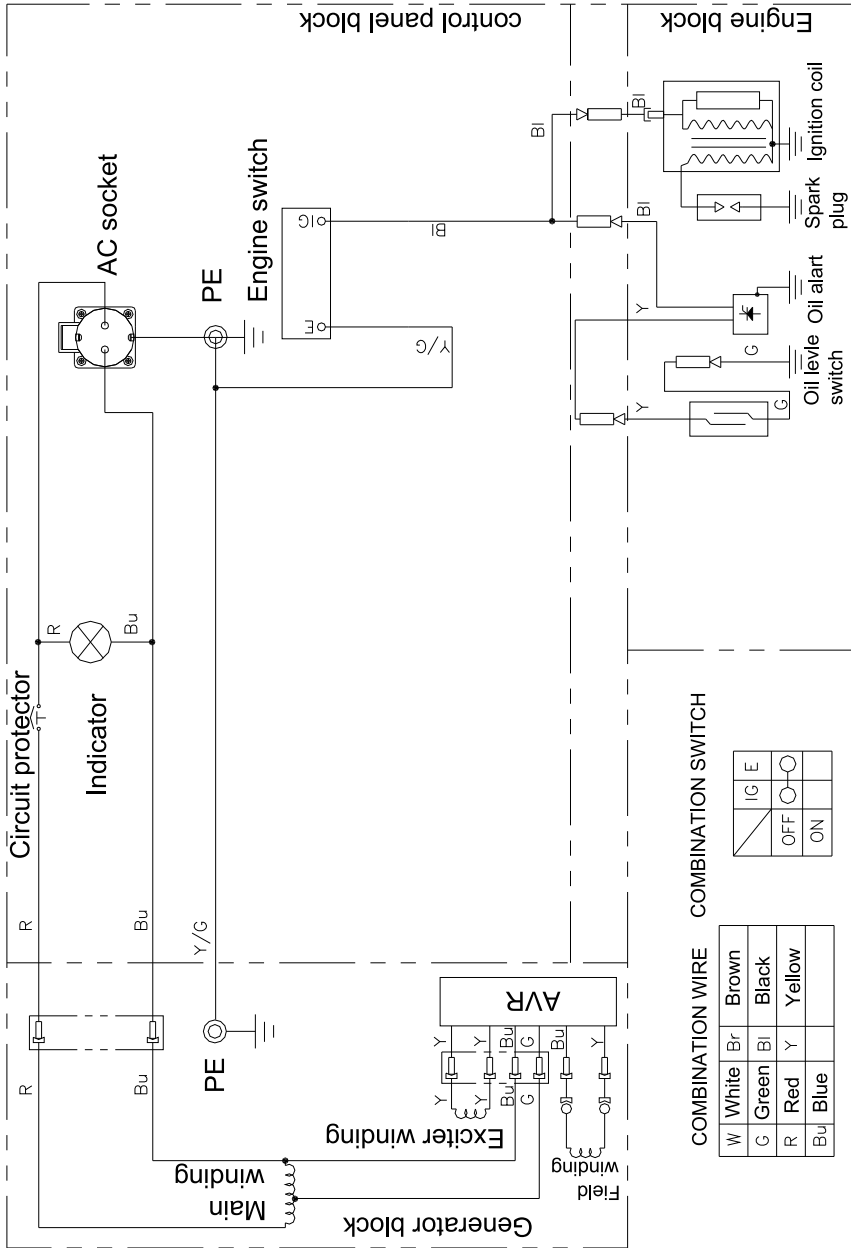



隆鑫通用动力股份有限公司
Loncin motor co., Ltd.

详细地址：重庆市九龙坡区九龙工业园区华龙大道99号

服务电话：023 8980 5678/8980 8505

传 真：023-8906 7566

邮政编码：400052

Email: marketing@loncinengine.com

Website: www.loncinengine.com

PRINTED IN CHINA